

Selector switch 2 positions

K14-506.22200

Distribution by
DigiKey

DigiKey



<https://digikey.eao.com/component/K14-506.222...>

Your product:



K14-506.22200

Selector switch 2 positions

Loading ...

FRONT

Front dimension:	Ø 35 mm
Front bezel colour:	Nature
Front bezel material:	Aluminium

MOUNTING

Mounting cut-out:	Ø 30.5 mm
Mounting type:	Panel mounting

OPERATING-/INDICATION PART

Lever colour:	Black
Lever material:	plastic
Lever shape:	short

ELECTRICAL CHARACTERISTICS

Switching voltage and switching current:	250 VAC, 5 A (ohmic) 250 VAC, 3 A (Soldering terminal) 250 VAC, 2 A (inductive, $\cos(\phi) = 0.7$) 220 VDC, 0.1 A (inductive, L:R = 30 ms) 110 VDC, 0.2 A (inductive, L:R = 30 ms) 60 VDC, 0.7 A (inductive, L:R = 30 ms) 24 VDC, 2 A (inductive, L:R = 30 ms)
Contacts:	1 NC / 1 NO
Rated Operational Voltage Ue:	250 VAC/DC according to EN IEC 61058-1
Switching rating:	250 V AC @ 3 A
Electrical lifetime:	50 000 cycles of operation
Electric strength:	

3000 VAC, 50 Hz, 1 min. between all terminals and earth, according to EN/IEC 61058-1

Protection class:	II
Standards:	According to EN/IEC 61058-1
Thermal current I_{th}:	3 A

MECHANICAL CHARACTERISTICS

Terminal:	Soldering terminal
Contact material:	Gold-plated silver
Switching action:	Rest - Maintained
Switching system:	Snap-action switching element
Switching positions:	2 positions
Switching angle:	90° right
Mechanical lifetime:	1 Mil. cycles of operation
Operating force:	5 N ... 8 N
Operating Travel:	ca. 90°
Tightening torque:	Fixing nut max. 0.25 Nm
Wire cross section:	Max. wire diameter 2 wires à 1.2 mm Max. wire cross-section of stranded cable 1 x 1 mm ²
Weight:	0.039 kg

AMBIENT CONDITION

IP front protection:	IP67, according to DIN EN 60529
Operating temperature:	- 25 °C ... + 55 °C
Storage temperature:	- 40 °C ... + 85 °C
Shock resistance:	Max. 150 m / s ² , pulse width 11 ms, 3-axis, (semi-sinusoidal as per EN IEC 60068-2-27)
Vibration resistance:	Max. 100 m / s ² from 10 Hz ... 500 Hz, (sinusoidal EN IEC 60068-2-6)
Climate resistance:	Standard condition, as per DIN EN 60068-2-78 Standard cyclic, as per DIN IEC 60068-2-30

CERTIFICATE

Approbations:	CB (IEC 61058-1), CQC, CSA, DNV, EAC, ENEC (EN 61058-1), UL, VDE
Conformities:	CE, UKCA, 2011 / 65 / EC (RoHS), 2014 / 35 / EU (LVD)

REACH: REACH compliant

RoHS: RoHS compliant

OTHER

Short Description: Selector switch 2 positions, Rest - Maintained, 250 V AC @ 3 A, 1 NC / 1 NO, Soldering terminal, Aluminium

Housing colour: Black

Housing material: Plastic

Hints: The colour of anodised aluminium parts can vary due to technical production reasons

max. number of switching elements: 1

Switching positions:

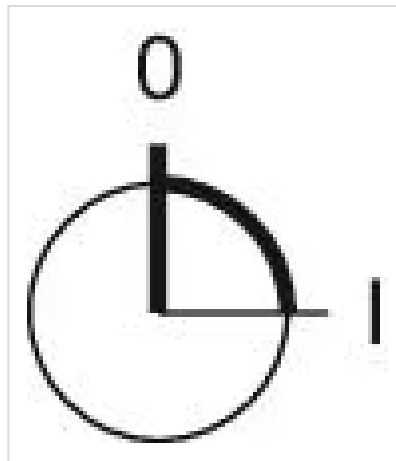

Wiring diagrams:

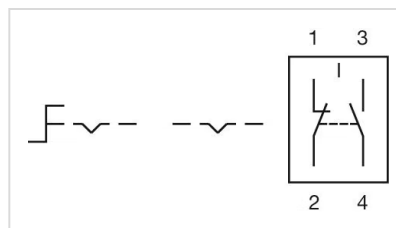

Mounting cut-outs:

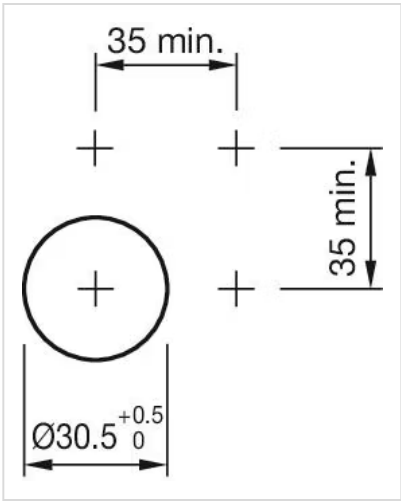

Dimension drawings:

