

Illuminated push button

K14-271.212052

Distribution by
DigiKey

DigiKey



<https://digikey.eao.com/component/K14-271.212...>

Your product:



K14-271.212052 Illuminated push button

Loading ...

FRONT

Front dimension: Ø 35 mm

Front form: Round

MOUNTING

Mounting cut-out: Ø 30.5 mm

Mounting type: Panel mounting

OPERATING-/INDICATION PART

Lens colour: Red

Lens material: Plastic

Lens illumination: Illuminated

Lens shape: Raised

Lens optics: transparent

Illumination colour: Red

ELECTRICAL CHARACTERISTICS

Switching voltage and switching current: 250 VAC, 5 A (ohmic)
250 VAC, 3 A (Soldering terminal)
250 VAC, 2 A (inductive, $\cos(\phi) = 0.7$)
220 VDC, 0.1 A (inductive, L:R = 30 ms)
110 VDC, 0.2 A (inductive, L:R = 30 ms)
60 VDC, 0.7 A (inductive, L:R = 30 ms)
24 VDC, 2 A (inductive, L:R = 30 ms)

Contacts: 1 NC / 1 NO

Operating voltage: 28 V AC/DC

Operation current: 2.5/5 mA ± 15 %

Rated Operational Voltage Ue:	250 VAC/DC according to EN IEC 61058-1
Switching rating:	250 V AC @ 3 A
Electrical lifetime:	50 000 cycles of operation
Electric strength:	3000 VAC, 50 Hz, 1 min. between all terminals and earth, according to EN/IEC 61058-1
Protection class:	II
Standards:	According to EN/IEC 61058-1
Thermal current Ith:	3 A

MECHANICAL CHARACTERISTICS

Terminal:	Plug-in terminal, 2.8 x 0.5 mm
Contact material:	Gold-plated silver
Switching action:	Maintained
Switching system:	Snap-action switching element
Switching system:	Self-cleaning, double-break snap action switching system (contact opening width 2 mm x 1.5 mm).
Mechanical lifetime:	1 Mil. cycles of operation
Operating force:	5 N ... 8 N
Operating Travel:	3 mm
Tightening torque:	Fixing nut max. 0.25 Nm
Wire cross section:	Max. wire diameter 2 wires of 1 mm Max. wire cross-section of stranded cable 2 of 0.75 mm ² or 1 x 1.0 mm ²
Weight:	0.031 kg

AMBIENT CONDITION

IP front protection:	IP67, according to DIN EN 60529
Operating temperature:	- 25 °C ... + 55 °C, mounted as a block, make sure the heat can escape freely
Storage temperature:	- 40 °C ... + 85 °C
Shock resistance:	Max. 150 m / s ² , pulse width 11 ms, 3-axis, (semi-sinusoidal as per EN IEC 60068-2-27)
Vibration resistance:	Max. 100 m / s ² from 10 Hz ... 500 Hz, (sinusoidal EN IEC 60068-2-6)
Climate resistance:	Standard condition, as per DIN EN 60068-2-78 Standard cyclic, as per DIN IEC 60068-2-30

CERTIFICATE

Approbations: CB (IEC 61058-1), CQC, CSA, DNV, EAC, ENEC (EN 61058-1), UL, VDE
Conformities: CE, UKCA, 2011 / 65 / EC (RoHS), 2014 / 35 / EU (LVD)
REACH: REACH compliant
RoHS: RoHS compliant

OTHER

Short Description: Illuminated push button, Maintained, 250 V AC @ 3 A, 28 V AC/DC, 1 NC / 1 NO, Plug-in terminal, 2.8 x 0.5 mm, Round, Red, Red
Housing colour: Black
Housing material: Plastic
Wiring diagrams:

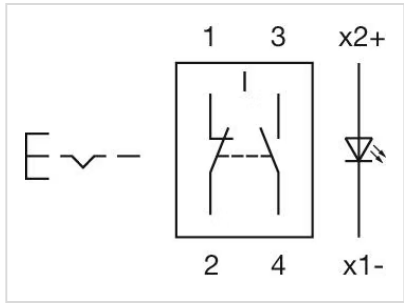

Mounting cut-outs:

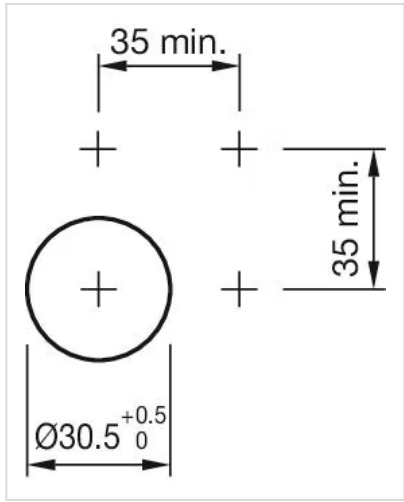

Dimension drawings:

