

# Illuminated push button

K14-131.211102

Distribution by  
DigiKey

**DigiKey**



<https://digikey.eao.com/component/K14-131.211...>

Your product:

---



## K14-131.211102 Illuminated push button

*Loading ...*

### FRONT

**Front dimension:** Ø 35 mm

**Front form:** Round

### MOUNTING

**Mounting cut-out:** Ø 30.5 mm

**Mounting type:** Panel mounting

### OPERATING-/INDICATION PART

**Lens colour:** Red

**Lens material:** Plastic

**Lens illumination:** Illuminated

**Lens shape:** Flush

**Lens optics:** transparent

**Illumination colour:** Red

### ELECTRICAL CHARACTERISTICS

**Switching voltage and switching current:** 250 VAC, 5 A (ohmic)  
250 VAC, 3 A (Soldering terminal)  
250 VAC, 2 A (inductive,  $\cos(\phi) = 0.7$ )  
220 VDC, 0.1 A (inductive, L:R = 30 ms)  
110 VDC, 0.2 A (inductive, L:R = 30 ms)  
60 VDC, 0.7 A (inductive, L:R = 30 ms)  
24 VDC, 2 A (inductive, L:R = 30 ms)

**Contacts:** 1 NC / 1 NO

**Operating voltage:** 28 V AC/DC

**Operation current:** 2.5/5 mA  $\pm 15$  %

<b>Rated Operational Voltage Ue:</b>	250 VAC/DC according to EN IEC 61058-1
<b>Switching rating:</b>	250 V AC @ 3 A
<b>Electrical lifetime:</b>	50 000 cycles of operation
<b>Electric strength:</b>	3000 VAC, 50 Hz, 1 min. between all terminals and earth, according to EN/IEC 61058-1
<b>Protection class:</b>	II
<b>Standards:</b>	According to EN/IEC 61058-1
<b>Thermal current Ith:</b>	3 A

### MECHANICAL CHARACTERISTICS

<b>Terminal:</b>	Plug-in terminal, 2.8 x 0.5 mm
<b>Contact material:</b>	Gold-plated silver
<b>Switching action:</b>	Momentary
<b>Switching system:</b>	Snap-action switching element
<b>Switching system:</b>	Self-cleaning, double-break snap action switching system (contact opening width 2 mm x 1.5 mm).
<b>Mechanical lifetime:</b>	2 Mil. cycles of operation
<b>Operating force:</b>	3 N ... 6 N
<b>Operating Travel:</b>	3 mm
<b>Tightening torque:</b>	Fixing nut max. 0.25 Nm
<b>Wire cross section:</b>	Max. wire diameter 2 wires of 1 mm Max. wire cross-section of stranded cable 2 of 0.75 mm <sup>2</sup> or 1 x 1.0 mm <sup>2</sup>
<b>Weight:</b>	0.031 kg

### AMBIENT CONDITION

<b>IP front protection:</b>	IP67, according to DIN EN 60529
<b>Operating temperature:</b>	- 25 °C ... + 55 °C, mounted as a block, make sure the heat can escape freely
<b>Storage temperature:</b>	- 40 °C ... + 85 °C
<b>Shock resistance:</b>	Max. 150 m / s <sup>2</sup> , pulse width 11 ms, 3-axis, (semi-sinusoidal as per EN IEC 60068-2-27)
<b>Vibration resistance:</b>	Max. 100 m / s <sup>2</sup> from 10 Hz ... 500 Hz, (sinusoidal EN IEC 60068-2-6)
<b>Climate resistance:</b>	Standard condition, as per DIN EN 60068-2-78 Standard cyclic, as per DIN IEC 60068-2-30

**CERTIFICATE**

**Approbations:** CB (IEC 61058-1), CQC, CSA, DNV, EAC, ENEC (EN 61058-1), UL, VDE  
**Conformities:** CE, UKCA, 2011 / 65 / EC (RoHS), 2014 / 35 / EU (LVD)  
**REACH:** REACH compliant  
**RoHS:** RoHS compliant

**OTHER**

**Short Description:** Illuminated push button, Momentary, 250 V AC @ 3 A, 28 V AC/DC, 1 NC / 1 NO, Plug-in terminal, 2.8 x 0.5 mm, Round, Red, Red  
**Housing colour:** Black  
**Housing material:** Plastic  
**Wiring diagrams:**

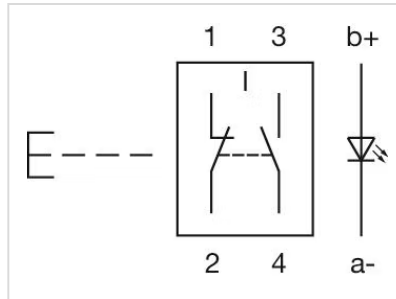

**Mounting cut-outs:**

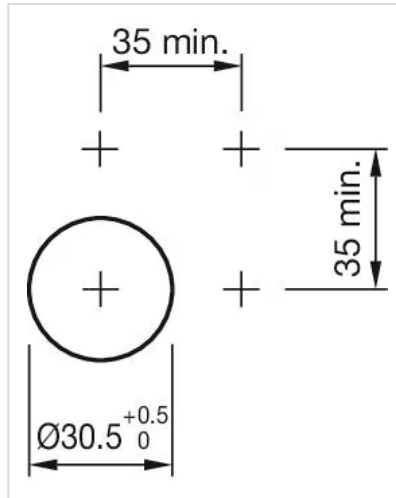

**Dimension drawings:**

