

Capacitive sensor switch with IO-Link Standard

Distribution by
DigiKey

DigiKey

84-ASKS-C12-04A4



<https://digikey.eao.com/component/84-ASKS-C12...>

Your product:



84-ASKS-C12-04A4

Capacitive sensor switch with IO-Link Standard

Loading . . .

FRONT

Front dimension: Ø 30 mm

Front form: Round

Front bezel material: Plastic

MOUNTING

Design: Flush

Mounting cut-out: Ø 22.5 mm

Mounting type: Panel mounting

OPERATING-/INDICATION PART

Lens material: Plastic

Lens illumination: Illuminated

Lens shape: Flush

Lens optics: transparent

Symbol: ON/OFF (C12)

ELECTRICAL CHARACTERISTICS

Operating voltage: 8.4 - 32 V DC

Communication interface: IO-Link specification

MECHANICAL CHARACTERISTICS

Terminal: Connector M12

Switching system: Capacitive
Operating force: No actuating force necessary
Weight: 0.015 kg

AMBIENT CONDITION

IP front protection: IP69K
IK front protection: IK08
Operating temperature: – 30 °C ... + 65 °C
Climate resistance: Relative humidity, max. 95%, non-condensing

CERTIFICATE

Approbations: CSA, EHEDG
Conformities: CE, UKCA
REACH: REACH compliant
RoHS: RoHS compliant

OTHER

Short Description: Capacitive sensor switch with IO-Link Standard, Ø 22.5 mm, Ø 30 mm, Flush, Illuminated, Plastic, transparent, Round, Plastic, Connector M12, IP69K, IK08, ON/OFF (C12)
Housing colour: Black
Housing material: Plastic
Wiring diagrams:

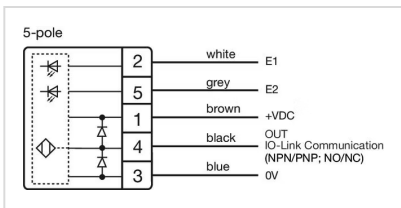
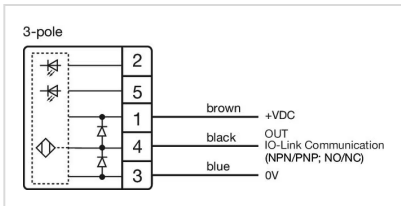
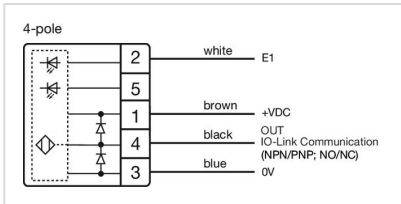

Component layouts:

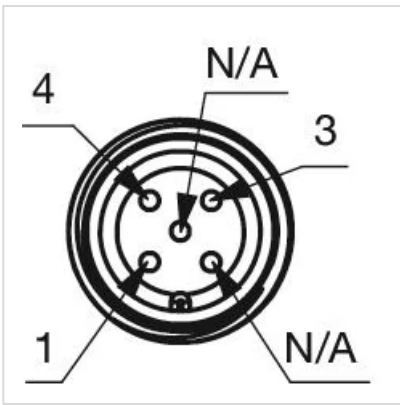
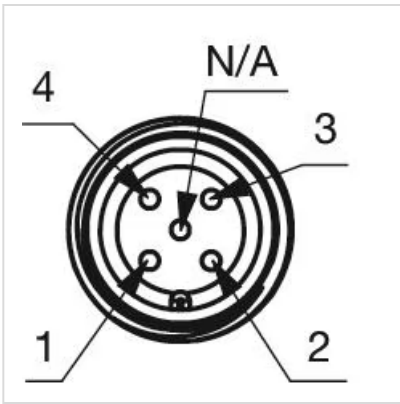
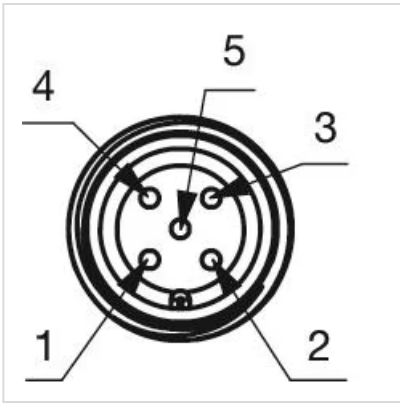

Mounting cut-outs:

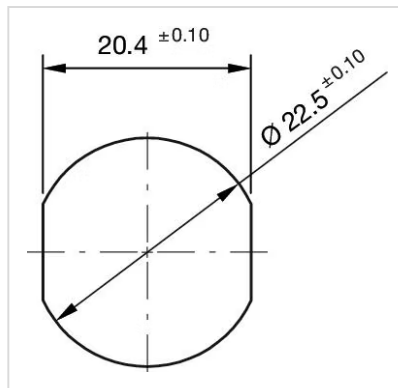

Dimension drawings:

