

Switching element - New Version

Distribution by
DigiKey

DigiKey

704.901.4-1

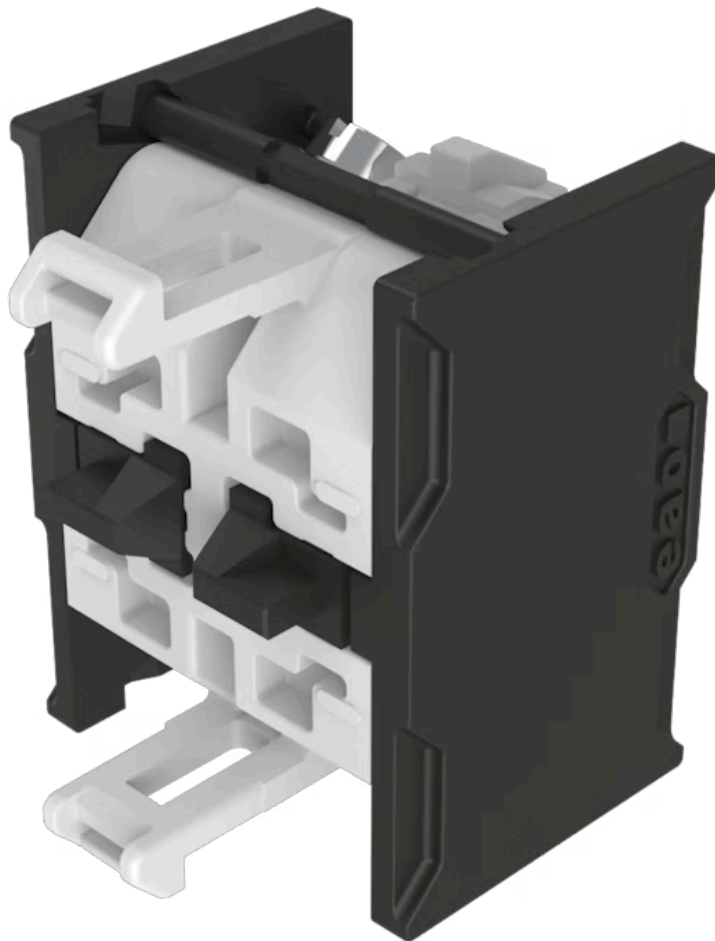

<https://digikey.eao.com/component/704.901.4-1...>

Your product:



704.901.4-1 Switching element - New Version

Loading ..

ELECTRICAL CHARACTERISTICS

Switching voltage and switching current:

as per DIN EN IEC 60947-5-1			
voltage		DC13	AC15
24 V		2,5 A	
60 V		0,8 A	
110 V		0,6 A	
120 V			4,5 A
230 V		0,2 A	4,5 A
400 V		0,15 A	4,0 A
500 V		0,7 A	2,5 A
as per UL 60947-5-1			
voltage		power	
24 VDC		2,5 A, Pilot duty	
60 VDC		0,8 A, Pilot duty	
120 VDC		0,6 A, Pilot duty	
240 VDC		0,2 A, Pilot duty	
415 VDC		0,15 A, Pilot duty	
480 VDC		0,07A, Pilot duty	
120 VAC		4,5 A, Pilot duty	
240 VAC		4,5 A, Pilot duty	
415 VAC		4,0 A, Pilot duty	
480 VAC		2,5 A, Pilot duty	
For voltages greater than $U_e = 400$ V, the grid dimensions must not be less than 35 mm x 50 mm.			

Contacts: 2 NC

**Rated impulse withstand voltage
 U_{imp} :** 4 kV

Rated insulation voltage U_i : 500 V

Recommended minimum operational data:

Gold-silver contacts			
Voltage	5 VDC	24 VDC	110 VDC
Current	15 mA	5 mA	2 mA
Hard silver contacts			
Voltage	24 VDC	110 VDC	
Current	50 mA	10 mA	

Switching rating: 500 V AC @ 10 A

Electrical lifetime: 50 000 cycles of operation (500 VAC, 10 A)

Pollution degree: 3

Standards: The switches comply with the "Standards for low-voltage switching devices" DIN EN IEC UL 60947-5-1

Thermal current I_{th}: Max. current as per EN IEC 60947-5-1 10 A

MECHANICAL CHARACTERISTICS

Terminal: Screw terminal

Contact material: Gold

Switching system: Snap-action switching element

Switching system: The double-break, snap-action switching element is equipped with one or two independent contact systems, acting as normally open or normally closed contact. The snap-action switching element is fitted with self-cleaning contacts.

Operating force: 1 Normally closed approx. 1.9 N, 1 Normally open approx. 2 N

Tightening torque: Screw terminal 0.8 Nm

Wire cross section: Wire cross-section 0.75 ... 2.5 mm² / AWG 18 to AWG 14
Skinning wire 10 mm
Max. number of wires: 2
Wire cross-section of stranded cable 0.5 ... 1.5 mm² / AWG 24 to AWG 18
use stranded wires only with wire end ferrules of 10 mm length
Max. number of stranded cables: 2
Only one polarity is allowed on each side when wiring.

Weight: 0.019 kg

AMBIENT CONDITION

IP Protection: IP00

Operating temperature: - 40 °C ... + 55 °C

Storage temperature: - 40 °C ... + 85 °C

Shock resistance: (single impacts, semi-sinusoidal) 300 m/s², pulse width 18 ms, as per DIN EN 60068-2-27

Vibration resistance: (sinusförmig) 100 m/s² bei 10 Hz...500 Hz, nach DIN EN 60068-2-6, Erhöhtes Breitbandrauschen nach DIN EN 61373, Klasse 1B

Climate resistance: Relative humidity 10 %rh ... 95 %rh (non-condensing) original packaging according to DIN EN IEC 60721-3-1 Class 1C1

CERTIFICATE

Approbations: CB (IEC 60947-5-1), cULus, DNV, VDE

Conformities: CE, CCC, UKCA

REACH: REACH compliant

RoHS: RoHS compliant

OTHER

Short Description:

Switching element - New Version, Snap-action switching element, 500 V AC @ 10 A, Gold, 2 NC, Screw terminal

Hints:

When using the switching element, the application guidelines must be observed. For the third switching element the terminal marking insert is to be ordered separately

Operating temperature: Other temperatures on request

A suitable enclosure is required for applications with increased protection requirements. In North America, the product must be installed in an enclosure in accordance with UL 50E Type 2 or higher.

Wiring diagrams:

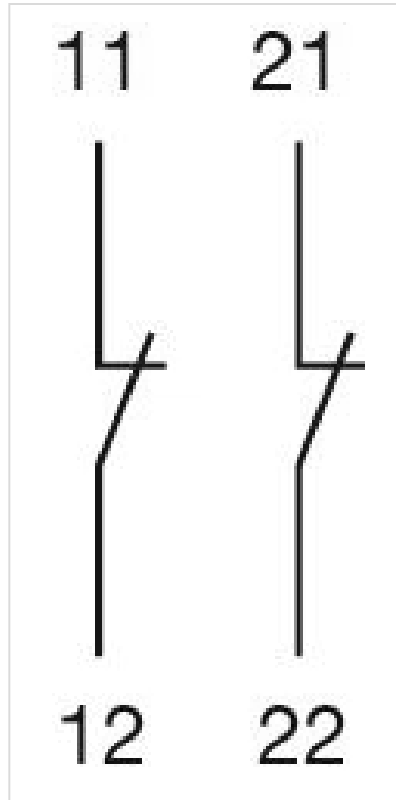

Dimension drawings:

