

Actuator

31-
703.006

Distribution by
DigiKey

DigiKey



<https://digikey.eao.com/component/31-703.006/...>

Your product:



31-703.006 Actuator

Loading ...

PRODUCT RANGE

Product Status: Not Recommended for new design

FRONT

Front dimension: 18 mm x 18 mm

Front form: Square

Front bezel colour: Black

Front bezel material: Plastic

MOUNTING

Design: Raised

Mounting cut-out: Ø 16 mm

Mounting type: Panel mounting

MECHANICAL CHARACTERISTICS

Terminal: Universal terminal, 2 x 0.5 mm

Weight: 0.006 kg

CERTIFICATE

REACH: REACH compliant

RoHS: RoHS compliant

OTHER

Short Description:

Actuator, Ø 16 mm, 18 mm x 18 mm, Square, Black, Plastic, Universal terminal, 2 x 0.5 mm

Internal size:

15,3 mm x 15,3 mm

Housing colour:

Black

Housing material:

Plastic

Wiring diagrams:

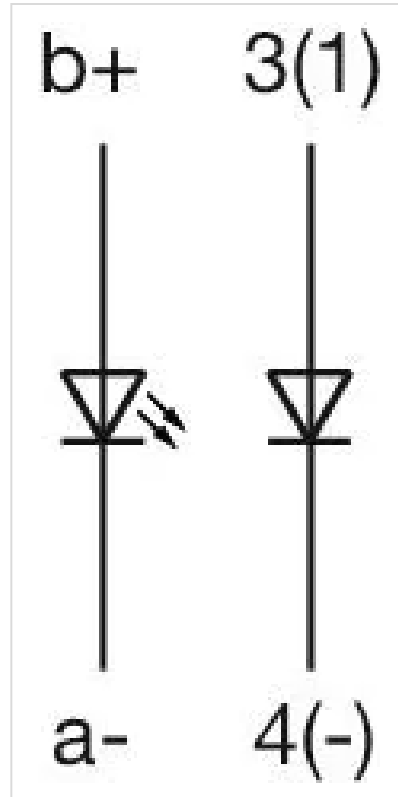

Component layouts:

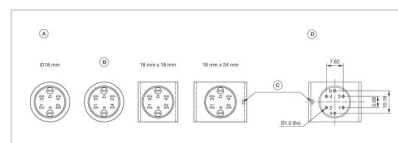

A = Terminals (rear side)

B = Diode block

C = Anti twist device only 18 mm x 24 mm

D = Drilling plan (component side)

Mounting cut-outs:

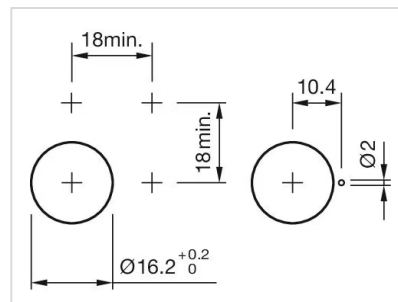

Dimension drawings:

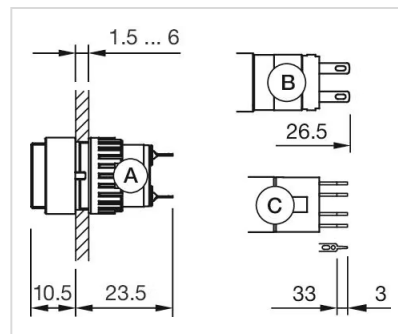

- A = Solder terminal
- B = Plug-in terminal 2.8 mm x 0.5 mm
- C = Universal terminal 2.0 mm x 0.5 mm